

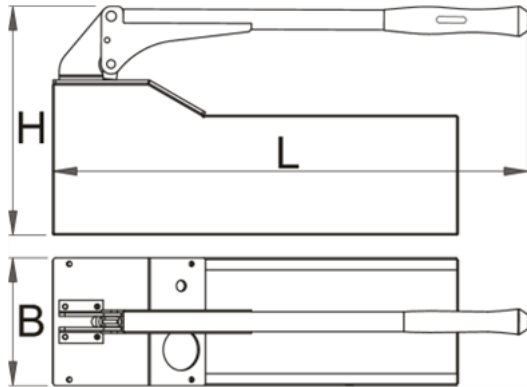



Pompa de testare - 375/6







Descriere

- este utilizata pentru testarea presiunii si scurgerilor de apa in instalatiile de incalzire ce lucreaza sub presiune
- capacitatea maxima - 12 litri
- confectionata din material anticoroziv

Date Tehnice

	L	B	H				
602600	605	160	286.5	8800	G	-	0

Date de ambalare

	Mod de reambalare.				Ambalare pentru transport.					
	L	A	B	C			A1	B1	C1	
602600	605	175	620	305	8800	1	175	620	305	8800